

eBore™

Fine Boring Tool



Boring tools for finish machining
Ø 24,5–205mm

Contents	Page
1. Basic safety information	3
2. Application and operation	3
3. Tool features	3
4. Operation	4–5
5. Maintenance	5
6. Accessories	5
7. Spare parts	6
8. Technical data	7

Kennametal tools are subject to constant further technical development. You can obtain up-to-date information from our product catalogue as well as on our website www.kennametal.com.

1. Basic safety information



Before first use, please read the operating instructions carefully. These provide important safety information and information concerning use and maintenance of the tool.

This precision boring tool is designed for finishing bores in metallic materials. Specific information on the machining of individual metallic materials is not the subject of these operating instructions. No other application is permitted and could be dangerous. The manufacturer cannot be held responsible for damage or injury caused by improper use.

A damaged tool could endanger your safety! Decommission the tool immediately and contact your suppliers.

This tool complies with the prescribed safety regulations. Repairs must be undertaken only by trained personnel. Improper repairs can represent a considerable risk for the user. Warranty provisions can be implemented only in the event that original Erickson spare and accessory parts are used.

Keep the Operating instructions for use in a safe place for future use.

2. Application and operation

The eBore precision boring tools are designed for precision holes from 24,5 – 205 mm diameter. The serie comprise of 9 single point boring tools (1), which can be equipped with insert holders (2) for different types of indexable inserts.

3. Tool features

- Precision boring tool with optional digital display in combination with an electronic positioning system. In digital mode the slider's adjustment range is measured directly
- On the machine side, the precision boring tool is equipped with a KM..TS connection (3) (Fig. 1).

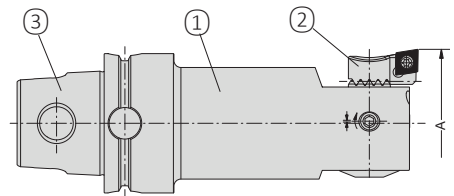
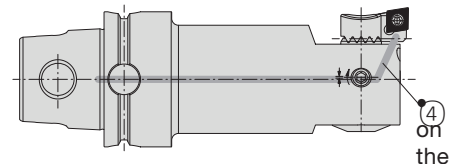

Fig. 1

- Precision threaded spindle for precision adjustment.
- Maintenance-free
- Internal coolant feed (4) to the cutting edge (Fig. 2). Max. permissible pressure 40 bar.



- Fig. 2 tool end, the tool is serrated for both frictional and positive engagement of insert holders taking various types of indexable inserts
- standard insert holders can be converted to carry out back boring from 36 mm bore diameters

Attention: Back boring then takes place with the machine spindle rotating anti-clockwise.

- Storage temperature:
– 10 °C to + 65 °C (14° F to 149° F).
- Operating temperature:
+ 10 °C to + 40 °C (50° F to 104° F).

4. Operation

Securing the insert holders

The slider (5) is especially profiled to fixed quick and easy different insert holders (2) (Fig. 3).

Torque for the insert holder screw, see Technical data page 12.

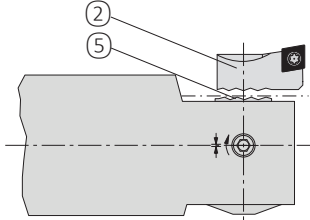

Fig. 3

Reverse machining (Fig. 4)

For back boring the insert holder is turned through 180° and mounted on the slider.

Attention: Back boring then takes place with the machine spindle rotating anti-clockwise.

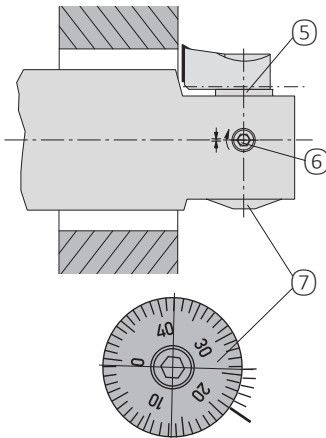

Fig. 4

Clamping (Fig. 4)

To clamp the slider (5) the tool is fitted with a clamping screw (6).

When removing metal, this clamping screw (6) must be used to clamp the slider (5). Before and after each adjustment, the clamping arrangement must be operated. Graduated dial (7) for the adjustment is located below the tool clamping point. Only one key is needed to operate both functions.



To avoid damage to parts of the adjustment mechanism, do not make any diameter adjustments in the clamped state.

Diameter adjustment

The matt chrome dial (7) gives an exact reading of the diameter setting. The distance of the adjustment is limited. Please follow the sequence of operations for setting the diameter as set out below.



To avoid damage to parts, never use force when carry out adjustment.

Adjustment of bore diameter (Fig. 4)

Please observe sequence:

1. Release threaded clamping pin (6)
2. Turn scale (7) to adjust tool diameter.

- On tool presetting device
- On machine using gage cut or trial drill
- 1 turn of scale:
0.5 mm adjustment in \emptyset
- 1 scale mark:
0.01 mm adjustment in \emptyset
- 1 vernier scale mark:
0.002 mm adjustment in \emptyset

2.1 Readjust tool (increase \emptyset) readjust scale to required value

or

2.2 Reset tool

- Determine value set on tool (Fig a, scale value 21)
- Turn scale back by one half-turn, left direction of rotation (Fig. b)
- Set new (smaller) scale value (Fig. c, scale value 20)

3. Tighten threaded clamping pin, tightening torque see Technical data page 12

The path of the slider is restricted. Any attempts to adjust against the end stop may damage the tool.

Example:

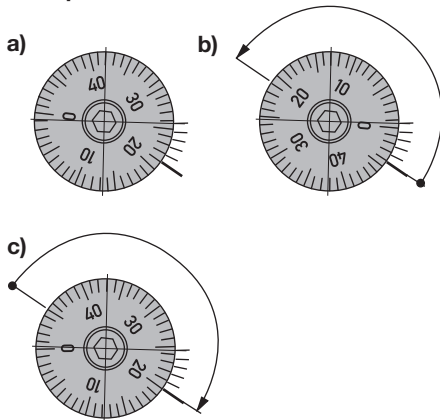

4.3 Setting the boring diameter with external digital display

The eBore fine boring tools can optionally be operated with an electronical measuring system with an digital readout module.

Please refer to the eBore external read-out module Operating Manual.

5. Maintenance

No maintenance required!

To ensure the tool has a long service life, it must be cleaned after use. A light film of oil should be applied to the visible, uncoated steel parts from time to time.

6. Accessories

Service keys

Service keys are included in the delivery.

Service key / Type	Order No.
s2.5 / DIN911	1138297
s4.0 / DIN911	1138315

Torx size / Type	Order No.
T 8 / FT	1021593
T 15 / FT	1021605
T 20 / FT	1021607

Type DIN911

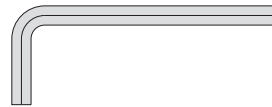

Type FT

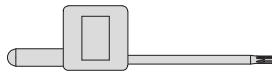

7. Spare parts

The individual parts comprising the adjusting mechanism have been very carefully matched and are not therefore replaceable.

The spare parts replaceable by the customer:
Clamping screw (6) and countersunk screw (8).

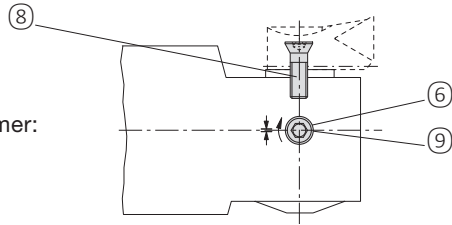

Boring range, mm (inch)	Precision boring tool Order No.	Countersunk screw (8) Order No.	Service key / Type	Clamping screw (6) Order No.	Service key / Type	Ball (9) Order No.
A						
24,5 - 29,0	6655290	6738825	T 15 / FT	–	s2,0 / DIN911	–
29,0 - 44,0	6655292	6738825	T 15 / FT	6738788	s2,5 / DIN911	6738789
43,0 - 54,0	6655294	6738825	T 15 / FT	3905854	s2,5 / DIN911	–
53,0 - 66,0	6655295	6738825	T 15 / FT	–	s3,0 / DIN911	–
65,0 - 83,0	6655297	6738786	T 20 / FT	3905766	s4,0 / DIN911	–
82,0 - 103,0	6655298	6738786	T 20 / FT	6763466	s4,0 / DIN911	–
100,0 - 130,0	6655299	6738786	T 20 / FT	6763466	s4,0 / DIN911	–
125,0 - 167,5	6655300	6738786	T 20 / FT	6763466	s4,0 / DIN911	–
162,5 - 205,0	6655301	6738786	T 20 / FT	6763466	s4,0 / DIN911	–

Screws for securing inserts

Insert form	Countersunk screw (9) Order No.	Service key Torx / Type
CC..06	6738799	T 8 / FT (1,2 Nm)
CC..09	6738796	T 15 / FT ((3,0 Nm)

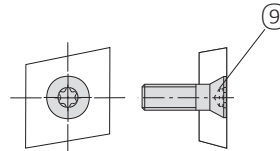

8. Technical data

Precision boring tool	Adjustment travel	Torque clamping screw (6)	Torque countersunk screw for securing the insert holder (8)	Max. speed when complete tool is balanced in 1/min.	Max. speed unbalanced in 1/min.
Order No.					
6655290	2,25 mm	2 Nm (17.7 in. lbs.)	3 Nm (26.55 in. lbs.)	13 000	6 500
6655292	4,00 mm	2 Nm (17.7 in. lbs.)	3 Nm (26.55 in. lbs.)	11 000	5 500
6655294	5,50 mm	2 Nm (17.7 in. lbs.)	3 Nm (26.55 in. lbs.)	7 500	3 750
6655295	6,50 mm	4 Nm (35.4 in. lbs.)	3 Nm (26.55 in. lbs.)	6 000	3 000
6655297	9,00 mm	6 Nm (53.1 in. lbs.)	5 Nm (44.25 in. lbs.)	5 000	2 500
6655298	10,50 mm	6 Nm (53.1 in. lbs.)	5 Nm (44.25 in. lbs.)	4 000	2 000
6655299	15,00 mm	6 Nm (53.1 in. lbs.)	5 Nm (44.25 in. lbs.)	3 200	1 600
6655300	21,25 mm	6 Nm (53.1 in. lbs.)	5 Nm (44.25 in. lbs.)	2 600	1 300
6655301	21,25 mm	6 Nm (53.1 in. lbs.)	5 Nm (44.25 in. lbs.)	2 000	1 000